

PANELTIM AGRO

Scandinavia ApS 



CATALOG WITH FITTING PARTS AND ASSEMBLY SAMPLES

We offer complete solutions, panels,
fitting parts, cribs, feeders and water systems
- all delivered to your adress

Optimal hygiene

Long durability

Quick cleaning

Easy assembly

Feel free to ask for an assistance with the drawings/design
and get a no-obligation offer.

+45 5545 0550 or info@paneltimagro.dk

For more information, visit our website: www.paneltimagro.dk

About

Paneltim® Agro Scandinavia

The company has supplied barn equipment to efficient pig producers for 40 years. Paneltim panels have been our main product since 1998.

Paneltim PP panels have now proven its quality for more than 26 years!



Easy installation

Assembly is carried out easily with ordinary tools and according to the accompanying drawing material.



Easy cleaning and high hygiene

Smooth surfaces and few mounting brackets provide a high level of hygiene. Washing time is 50% less than similar stable equipment.



Long durability

Panels made of polypropylene and fittings in stainless steel ensure unrivaled quality and long durability. Quality at competitive prices.



Sustainability

Paneltim offers to take back used panels for 100% recycling. 50% of our production is currently recycled.

Paneltim® Agro Scandinavia

At Paneltim Agro Scandinavia, we specialize in high-quality PP panels designed for optimal hygiene, quick cleaning, durability, and easy installation.

Our commitment to sustainability and innovation ensures that our panels meet your needs while contributing to a greener future.

Why Choose Paneltim Agro Scandinavia?

Tailored Solutions: We deliver custom-fit panels and equipment based on your specifications, ensuring they arrive quickly and ready for installation.

Sustainable and Eco-Friendly: All our panels are made from 100% recyclable polypropylene, and our fittings are crafted from stainless steel, promoting sustainability without compromising strength or quality.

Efficient Installation: Designed with a strong self-supporting ability, our panels reduce the need for extra brackets, providing a smooth, seamless finish that is easy to clean and maintain.

Expertise and Reliability: With over 35 years of experience, we provide reliable solutions for both new installations and renovations, ensuring functionality and comfort in any setting.

Our Process: Simple and Effective

- 1. Consultation & Design** – We collaborate with you to understand your specific needs and create custom plans.
- 2. Production Excellence** – Our panels are manufactured with precision, using recyclable materials for high durability and performance.
- 3. Direct Delivery & Installation** – Fast and efficient delivery to your site, with panels that are easy to install and maintain.
- 4. Sustainable Practices** – We are committed to eco-friendly solutions, ensuring all materials are recyclable and support a sustainable future.

Get in contact with us

To learn how our innovative panel solutions can meet your needs and transform your space



Hans H. Christensen
CFO/Sales
E-mail: hh@paneltimagro.dk



Niels F. Jensen
Sales
E-mail: nfj@paneltimagro.dk

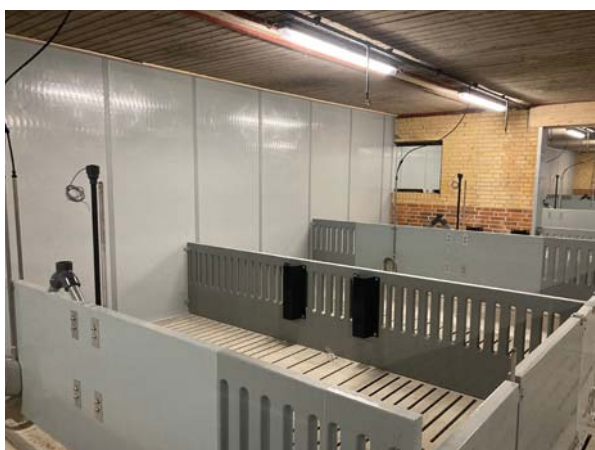

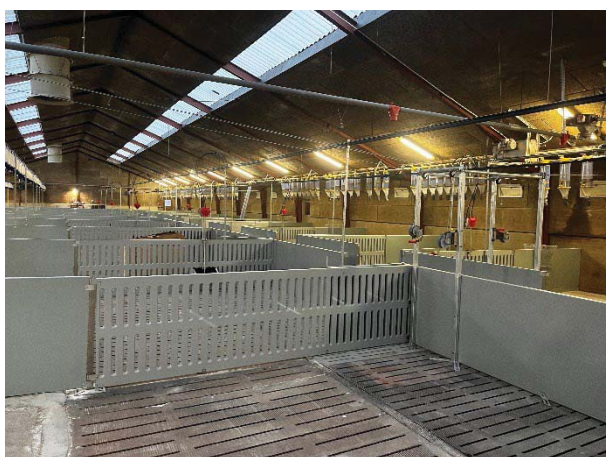
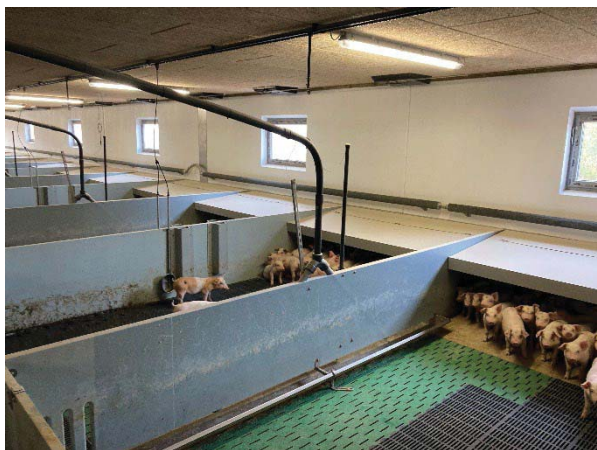

All panels is delivered on customized mesures.

- All panel types is made on customized length according to the individual projects.
- Different panel types can be weldet togheter in combinations.
- Different heigths can be welded togheter in combinations.

50 mm

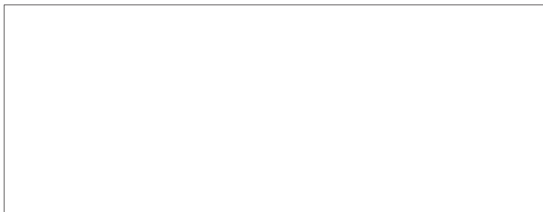

Closed Panel

Standard Height 800/1000/1200 x L
Heights on demand 400/500/600

Max lenght: 6000

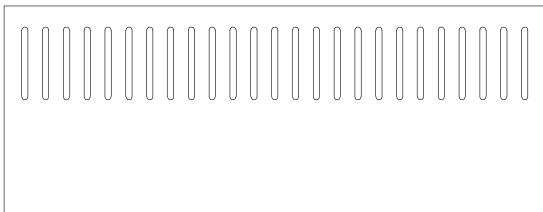

Venti Panel

Standard Height 800/1000/ x L

Max lenght: 6000

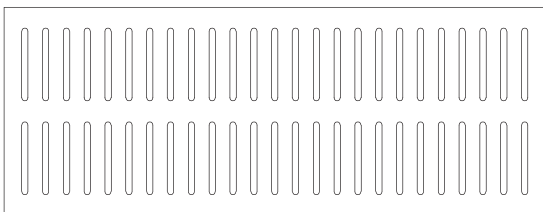

Double Venti Panel

Standard Height 1000/ x L

Max lenght: 6000

35 mm



Closed Panel

Standard Height 800/1000 x L
Heights on demand 400/500/600

Max lenght: 6000

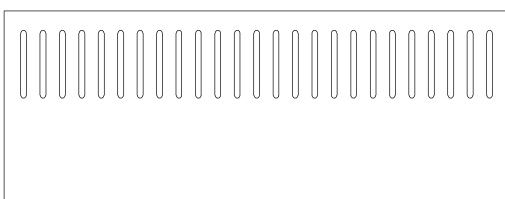

Venti Panel

Standard Height 800/1000/ x L

Max lenght: 6000

All mesures in mm.

Examples of different panel combinations

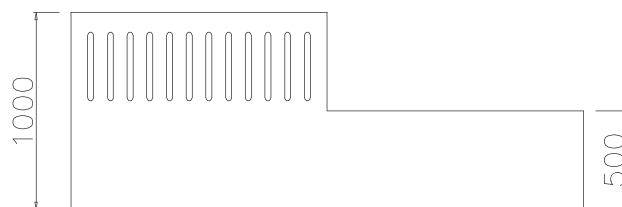
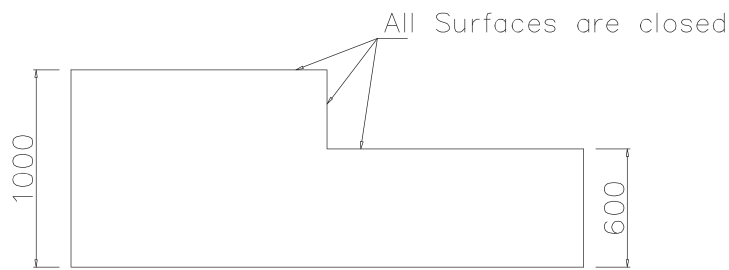
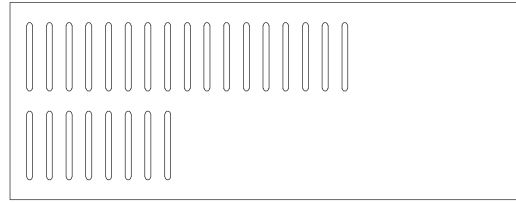

Panels with build in feeding pipes

- Our feeding pipes are build into the panel, leaving a smooth surface for easy washing.
- This panel can be welded together with our different panel types.
- We have fittings for both polymer crips and stainless-steel crips

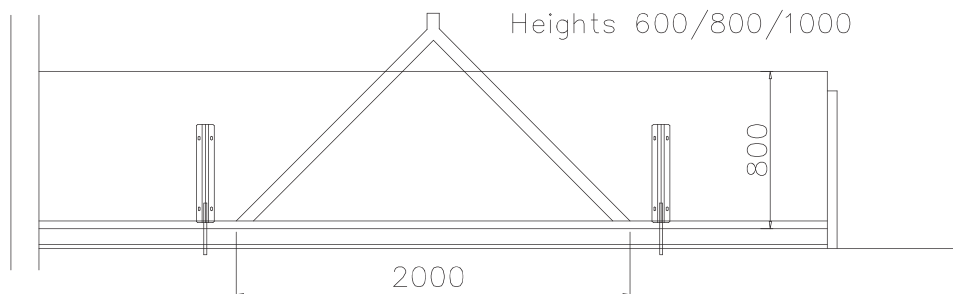

All measures in mm.

Paneltim® Agro panels

Side/page 7

Paneltim® Ultralight

NEW

Characteristics

- Due to the extra large cells of 100 mm x 100 mm, the panel is very light which makes large dimensions surprisingly easy to handle.
- Paneltim® Ultralight panels are suitable for pen partitions for goats, dogs, calves, cats, sheep, pigs ...

Colours



Specifications

Depths:	35 mm
Cells:	100 mm x 100 mm
Sizes:	1,200 mm x 800 mm 1,200 mm x 1,000 mm
Weight:	8 kg/m ²
Wall thickness:	3.5 mm
Material:	Recycled* Near to Prime

Paneltim® Lightweight

Characteristics

- Paneltim® Lightweight panels are light, rigid and closed all around.
- The panels are perfectly suitable for pen partitioning, pen doors, non-load-bearing walls, inside doors, in short applications where a light, strong and hygienic solution is needed.
- It is easy to create large surfaces and heights.

Colours



Specifications

Depths:	50 mm 20 mm
Cells:	100 mm x 50 mm
Sizes:	1,200 mm x 800 mm (50 mm 20 mm) 1,200 mm x 1,000 mm (50 mm 20 mm) 2,600 mm x 1,000 mm (50 mm)
Weight:	50 mm: ± 10 kg/m ² 20 mm: ± 8 kg/m ²
Wall thickness:	3.5 mm
Material:	Recycled* Near to Prime

Paneltim® Multipower

Characteristics

- Paneltim® Multipower is the strongest and most robust panel in the assortment.
- This panel is suitable for barns (pen partitioning, pen doors ...) for large animals.

Colours

Gray &



Specifications

Depth:	50 mm
Cells:	50 mm x 50 mm
Size:	1,200 mm x 1,000 mm
Weight:	± 12 kg/m ²
Wall thickness:	3.5 mm
Material:	Recycled*

ALL PANELS ARE
MADE OF PP.



Paneltim® Venti®

Characteristics

- The openings in the Venti® panels improve air circulation in barns.
- Due to the visual contact through the small openings, the panels help to reduce stress.
- The visual contact between the animals also controls their dunging behavior.

Colours



Specifications

Openings:	350 mm x 30 mm every 100 mm
Depths:	50 mm 35 mm
Cells:	50 mm: 100 mm x 100 mm
	35 mm: 100 mm x 50 mm
Sizes:	50 mm: 1,200 mm x 1,000 mm
	35 mm: 1,200 mm x 1,000 mm 1,000 mm x 800 mm
Weight:	50 mm: ± 9 kg/m ²
	35 mm: ± 8 kg/m ²
Wall thickness:	3.5 mm
Material:	Recycled* Near to Prime

NEW

NEW

Paneltim® Double Venti®

Characteristics

Thanks to the double row of openings, Paneltim® Double Venti contributes to an even better airflow in the barn which helps you create an optimal climate in your barn.

Colours

Gray



Specifications

Openings:	2 rows
	350 mm x 30 mm every 100 mm
Depth:	50 mm
Cells:	100 mm x 100 mm
Size:	1,200 mm x 1,000 mm
Wall thickness:	3,5 mm
Material:	Recycled*

Paneltim® Antislip

Characteristics

- All types are light, strong and closed all around so that you can easily clean them.
- Tests indicate that our anti-slip panels have high surface roughness in wet and dry conditions.
- Due to their high surface roughness, they are very suitable as floor elements in hallways and on stairs, as well for covers.

Colours



Specifications

Structures:	Five bars Studs
Depth:	50 mm
Cells:	50 mm x 50 mm
Size:	1,200 mm x 1,000 mm
Weight:	± 12 kg/m ²
Wall thickness:	3.5 mm
Material:	Recycled*

* Recycled panels: Colour shade may vary per production run.

Agri Door:

- Inside door with PVC plate and isolated core 40mm. RAL 7040 light grey.
- Outside door with reinforced glass fiber plate and isolated core 40mm. RAL 9016 White.
- The door is available in standard sizes, but also sizes on demand.
- Optional, Plexiglass or termoglass can be installed.
- The stainless-steel frame fits to all door holes and wall types with minimum thickness on 50mm
- The door can have full frame or with a flat steel bottom.

Section walls

- Our panels can be used as section walls as well. Panels for walls is 1000mm width and up to 6-meter lengths.
- We have different profiles to fit the panels to walls and connecting together.
- Panels and Profiles is in color light grey.

Standart sizes doors:

750x2000mm	1000x2000mm
750x2125mm	1000x2125mm
875x2000mm	1000x2375mm
875x2125mm	1250x2000mm
875x2375mm	1250x2125mm

Profiles for section walls

All profiles for section walls comes in 3-meter lengths:

- PVC H-profile
- PVC U-profile
- PVC L-profile
- Stainles steel U-Profile

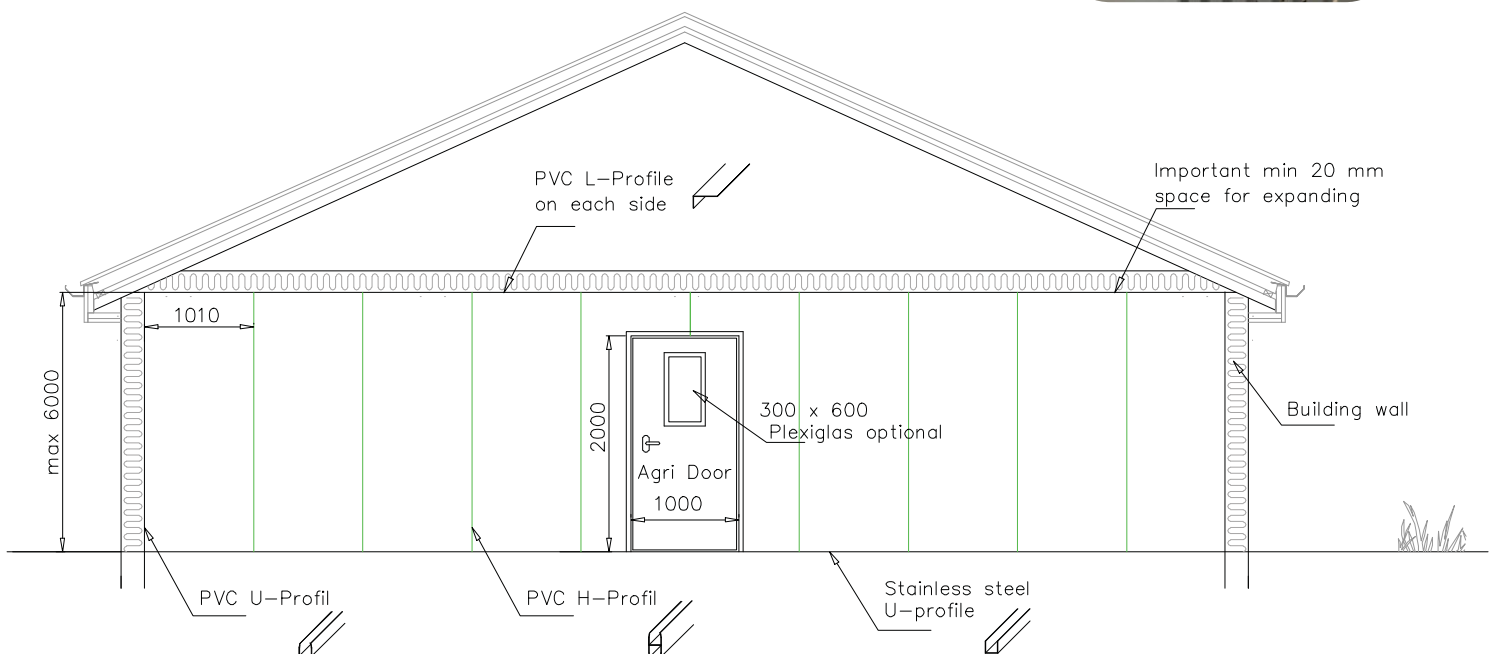

For more information, visit our website: www.paneltimagro.dk

Nr. P01

50mm tee/T unite
Eur 9,80 - Dkk 74,00

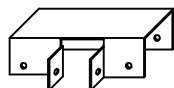

Nr. P06A

Vinkelbolt til hængselbæltap /
angle bolt for hinge
Eur 2,80 - Dkk 21,50



Nr. P02

45x45mm vinkel/angle
Eur 2,30 - Dkk 17,50



Nr. P07

U-profil m. 8mm støttebolt
U-profile with 8mm support bolt
Eur 6,20 - Dkk 47,00



Nr. P03A

50x150mm vinkel/angle
Eur 5,80 - Dkk 44,00

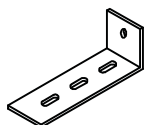

Nr. P08

Lukkebeslag / clinker
Eur 9,20 - Dkk 69,00



Nr. P03H

50x160mm vinkel højre/
angle right
Eur 8,80 - Dkk 66,00

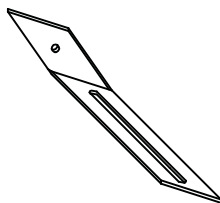

Nr. P08A

50 mm lang lukkebeslag / long clinker
Eur 8,80 - Dkk 66,00

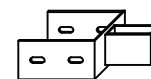

Nr. P03V

50x160mm vinkel venstre/
angle left
Eur 8,80 - Dkk 66,00

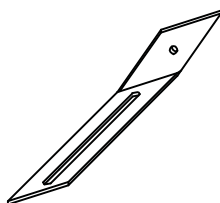

Nr. P08B

50 mm lukkebeslag / clinker
Eur 8,90 - Dkk 67,00



Nr. P04

50mm u-profil/straight unite
Eur 6,30 - Dkk 47,50

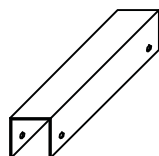

Nr. P09

50 mm styr lukkebeslag /
support for closing spear
Eur 13,80 - Dkk 103,50

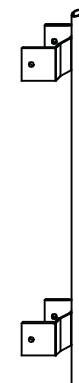

Nr. P05H

50mm vinkel samlestykke
højre/angle unite right
Eur 9,60 - Dkk 72,00

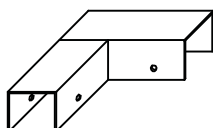

Nr. P10

50 mm lågehængsel/
door hinge 800mm
Eur 21,70 - Dkk 163,00

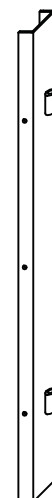

Nr. P05V

50mm vinkel samlestykke
venstre/angle unite left
Eur 9,60 - Dkk 72,00

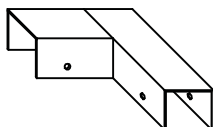

Nr. P06

50mm hængselbæltap/hinge
Eur 9,80 - Dkk 74,00



You are always welcome for a non-binding offer:

Tlf.: +45 5545 0550 | info@paneltimagro.dk | www.paneltimagro.dk

Nr. P11

Lukkespyd/closing spear
Eur 9,80 - Dkk 74,00



Nr. P16

Stabiliserings dorn polykrybber/
Crip stabilizer
Eur 20,40 - Dkk 153,00



Nr. P12

Væghængsel/wall hinge
Eur 22,00 - Dkk 165,00



Nr. P18

Vinkel/angle
Eur 12,60 - Dkk 94,50

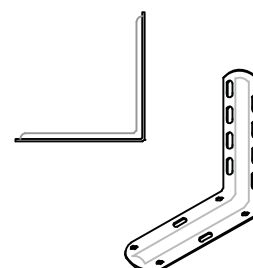

Nr. P13

Lukkebeslag væg/clinker to wall
Eur 5,60 - Dkk 42,50



Nr. P56

Spalteanker 80-100mm betonspalter
Eur 4,20 - Dkk 32,00



Nr. P13A

Lukkebeslag væg lang/clinker to wall long
Eur 5,90 - Dkk 44,50

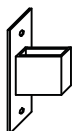

Nr. P3305

Skrueranker plastriste (10 stk.)
Slagnøgle må ikke bruges til bespænding
An impact wrench must not be used
for tightening
Eur 45,20 - Dkk 339,00



Nr. P3310

Tunge galv. triangel/støbejernsriste
Eur 2,80 - Dkk 21,00



Nr. P14

50mm samle kryds/cross unite
Eur 22,50 - Dkk 169,00

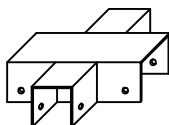

Nr. P3315

T-bolt beton 115mm
Eur 4,20 - Dkk 31,80



Nr. P15

Lågesikring / door fuse
Eur 6,90 - Dkk 52,00



Nr. P3320

T-bolt beton 160mm
Eur 4,70 - Dkk 35,40



Nr. P70

Lukkebeslag væg, solukketøj/
wall clinker sow closure
Eur 6,40 - Dkk 48,00

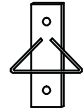

Nr. P3325

Slat - Fix beton
Eur 2,50 - Dkk 19,00



Nr. P71

Parkerings beslag solukketøj/
parking part for sow closure
Eur 5,80 - Dkk 44,00

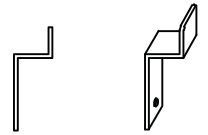

Nr. P3330

Slat-fix Plastriste
/plastic slats
Eur 2,00 - Dkk 15,00



Nr. P78

50mm U profil
højde 1000mm
Eur 20,40 - Dkk 153,50



Nr. P69

50mm solukketøj/
sow closure
Eur 58,60 - Dkk 440,00

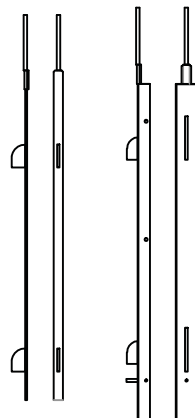

Nr. P245

800mm afstivningsvinkel v.dør/
end angle at door
Eur 39,70 - Dkk 298,00

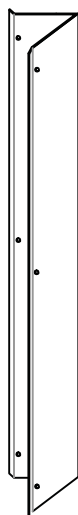

Nr. P87

780mm stolpe/
support post
Eur 58,60 - Dkk 440,00

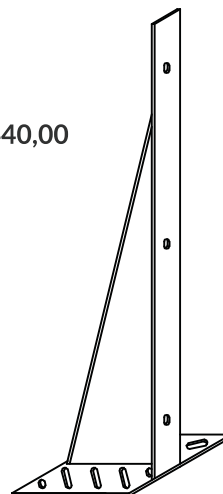

Nr. P79

50mm H profil
højde 1000mm
Eur 46,50 - Dkk 349,00

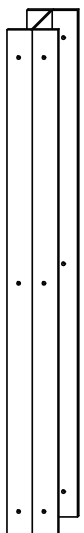

Nr. P101

Standard låge hængsel/
standard door hinge
Eur 15,60 - Dkk 117,00

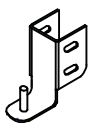

Nr. P102

Låge sko/
door shoe
Eur 4,50 - Dkk 34,20



Nr. P101 V

Låge hængsel venstre/
door hinge left
Eur 15,60 - Dkk 117,00

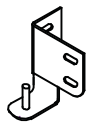

Nr. P102A

Låge sko flex/
door shoe flex
Eur 4,50 - Dkk 34,20



Nr. P101 H

Låge hængsel højre/
door hinge right
Eur 15,60 - Dkk 117,00

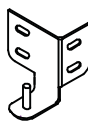

Nr. P103

50mm støttehjul til låge/
support wheel for door
Eur 30,10 - Dkk 226,00

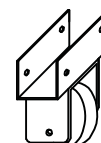

Nr. P101 F

Låge hængsel flad/
door hinge flat
Eur 15,60 - Dkk 117,00

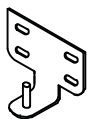

Nr. P109

50mm overfaldsluk
simple closure
Eur 30,00 - Dkk 225,00

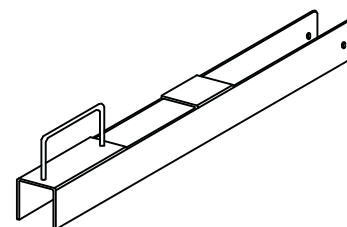

Nr. P101 L

Låge hængsel lang/
door hinge long
Eur 16,80 - Dkk 126,00

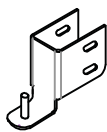

Nr. P125

Man-Gate for sow
Eur 308,60
Dkk 2315,00

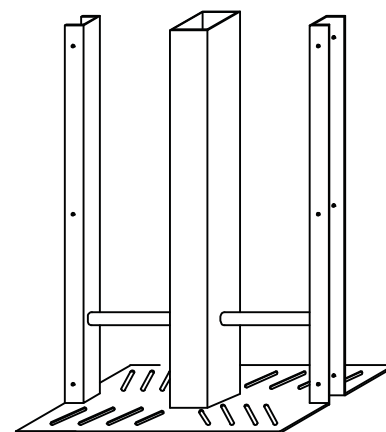

Nr. P101 L/V

Låge hængsel lang venstre/
door hinge long left
Eur 16,80 - Dkk 126,00

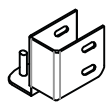

Nr. P101 L/H

Låge hængsel lang højre/
door hinge long right
Eur 16,80 - Dkk 126,00

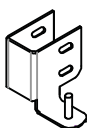

Nr. P101 L/H-V

Låge hængsel lang højre-venstre/
door hinge long right-left
Eur 26,10 - Dkk 196,00

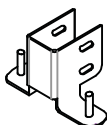

Nr. P135

Krybbe stiver Rf.krybbe/
panel support stainless crib
Eur 16,20 - Dkk 122,00

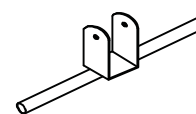

Nr. P101 L-3

Lågehængsel Lang med 3 hængsler/
Door hinge long with 3 hinges
Eur 35,00 - Dkk 262,00

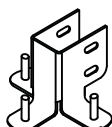

Nr. P300

Stolpe/post

Special

800mm
1200mm
2000mm

Standard

1000mm

Eur 64,50 - Dkk 484,00

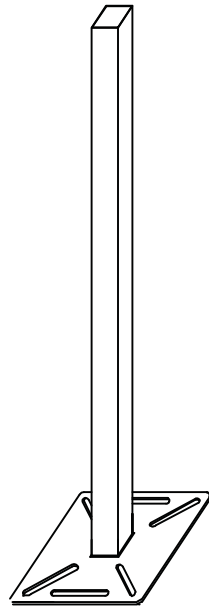

Post system 300

Nr. P320

Nr. P101 L

Nr. P300

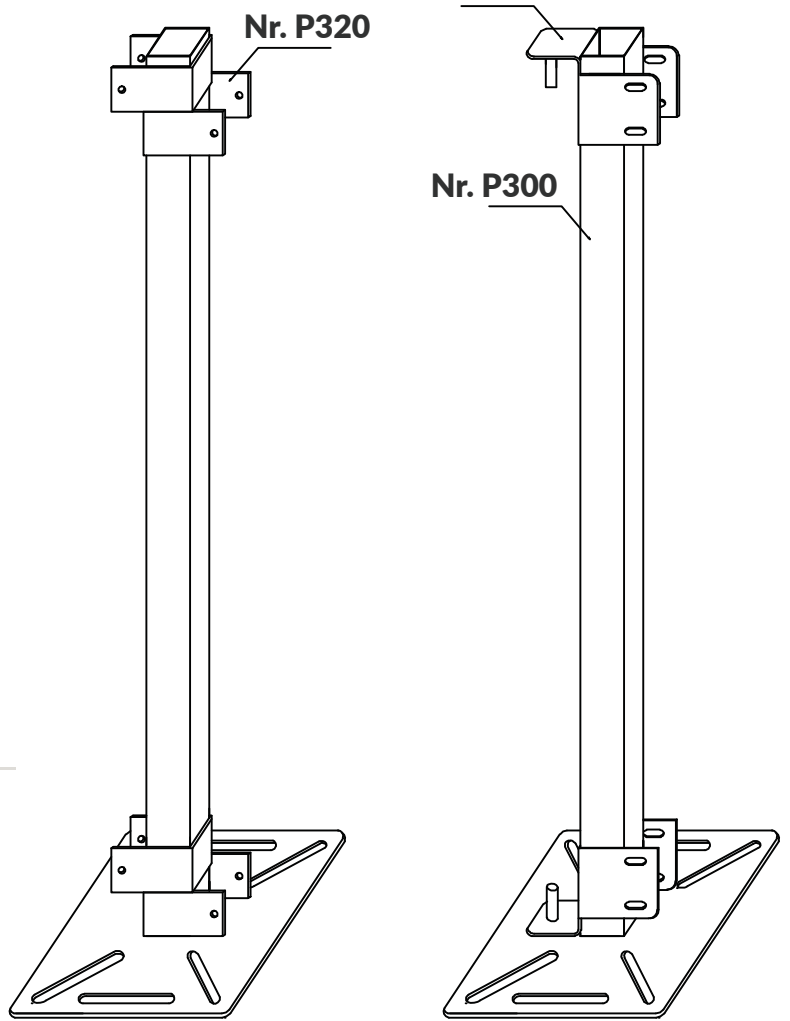

Nr. P320

Gaffelbeslag F/P300
connect bracket P300 panel
Eur 5,60 - Dkk 42,00

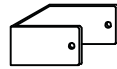

Nr. P64

Galv Stolpe/post

500mm

Eur 40,50 - Dkk 304,00

Nr. P65

Galv Stolpe/post

800mm

Eur 42,50 - Dkk 319,00

Nr. P66

Galv Stolpe/post

1000mm

Eur 46,50 - Dkk 349,00

Nr. P67

Galv Stolpe/post

2000mm

Eur 77,80 - Dkk 584,00

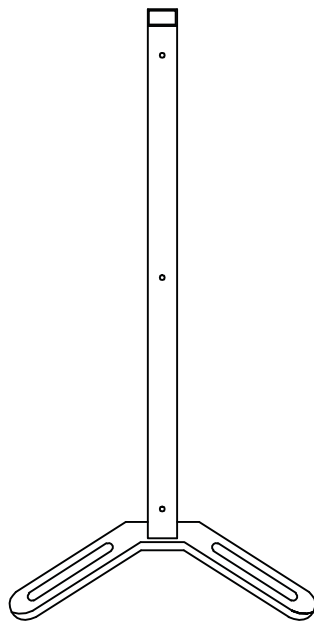

High 800 - 1000 - 1200 - 2000 mm

Nr. P101 L/V

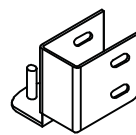

Nr. P101 L/H

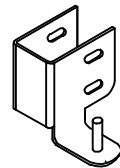

Nr. P101 L-3

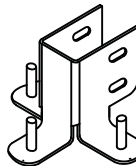

Nr. P101 L/H-V

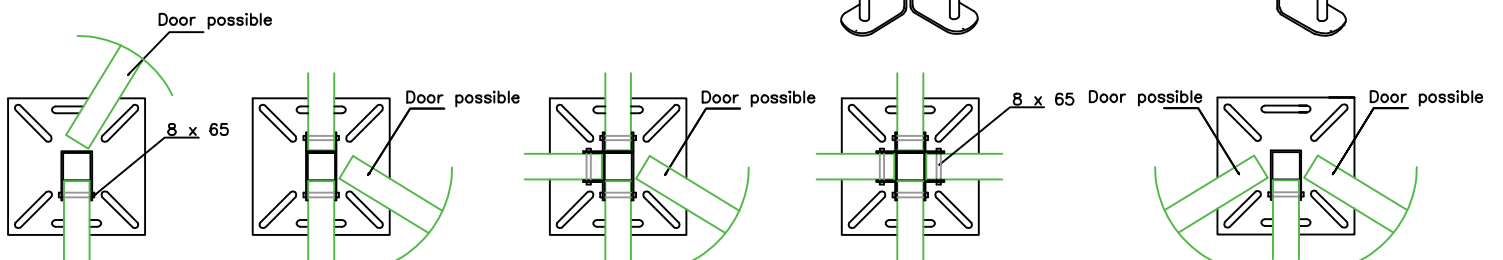
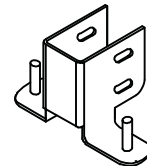

Nr. T01

35mm tee/ T unite
Eur 7,20 - Dkk 54,00

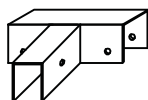

Nr. T04

35mm U-profil/straight unite
Eur 5,90 - Dkk 44,50

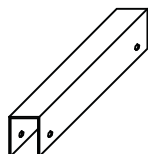

Nr. T08B

35mm lukkebeslag/clinker
Eur 6,90 - Dkk 52,00

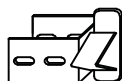

Nr. T09

35mm styr lukkebeslag/
support for closing spear
Eur 10,90 - Dkk 82,00

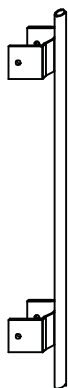

Nr. T101

35mm Lågehænge/door hinge
Eur 13,60 - Dkk 102,00

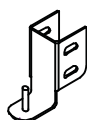

Nr. T102

35mm Låge sko/door hinge
Eur 3,20 - Dkk 24,00



Nr. T109

35mm overfaldsluk/
simple closure
Eur 34,90 - Dkk 262,00

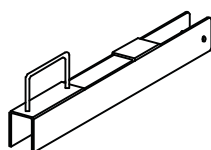

Nr. P11

Lukkespyd/closing spear
Eur 9,80 - Dkk 74,00



Nr. T81

U-profil til 35mm spærreplade/
U-profile for barrier plate
Eur 13,80 - Dkk 104,00

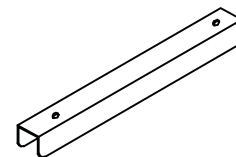

Nr. P75

Hængsel til 20mm overdækning/
hinge for 20mm cover
Eur 7,10 - Dkk 53,50

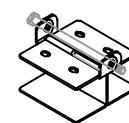

Nr. P76

Sidevinkel til
overdækning/
side angle for cover
Eur 11,30 - Dkk 85,00

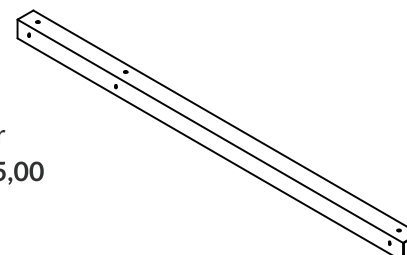

Nr. P77

Hyldeknægt til overdækning/
bearing for cover
Eur 6,00 - Dkk 45,50

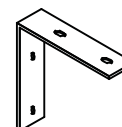

Bolt A2

8x25mm

Eur 0,26 - Dkk 1,92



Disk A2

10,5x5x30mm Washer A2

Eur 0,25 - Dkk 1,92



Bolt A2

8x50mm

Eur 0,34 - Dkk 2,55

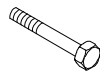

Nylon washer

13x37x3mm Washer A2

Used for lower door hinges P101 series

Eur 0,38 - Dkk 2,91



Bolt A2

8x65mm

Eur 0,48 - Dkk 3,66

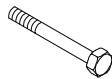

P55 A2

Ø 45 mm Skive/washer

Used for mounting when parts are only mounted on one side of the panel.

Eur 0,45 - Dkk 3,30



Bolt A2

8x75mm

Eur 0,64 - Dkk 4,73

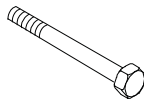

ScrewA2

8x60mm

Eur 0,70 - Dkk 5,58

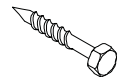

Bolt A2

8x120mm

Eur 0,94 - Dkk 7,00

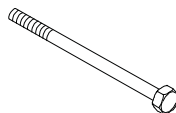

ScrewA2

10x70mm

Eur 0,90 - Dkk 6,93

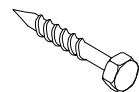

Lock nut A2

8mm

Eur 0,12 - Dkk 0,90



Plug

10mm

Eur 0,24 - Dkk 1,80



Disk A2

8,4x24mm Washer A2

Eur 0,10 - Dkk 0,75



Plug

12mm

Eur 0,38 - Dkk 2,85

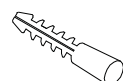

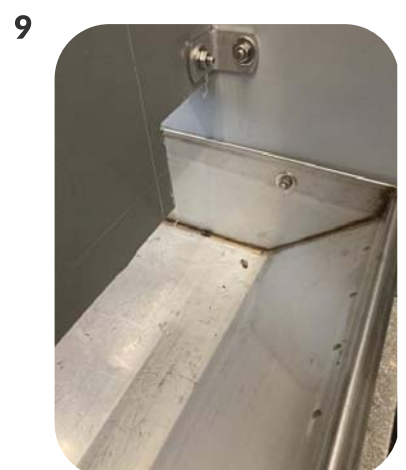
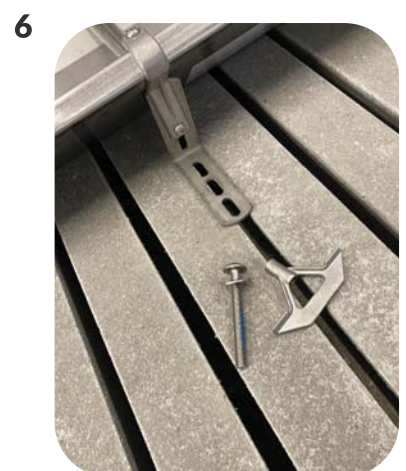
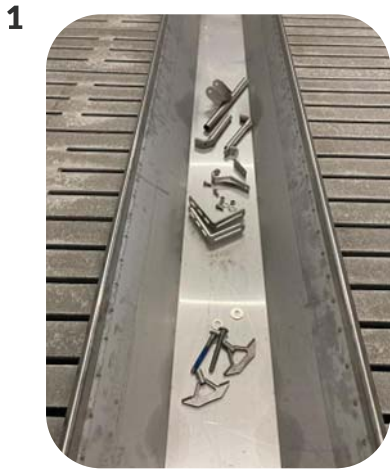

Nr. P16

P16 stabiliserings dorn til polykrybber/Crib stabilizer

Hullet i polykrybber bores i samme mål som dornen. Brug af et slidt bor giver det bedste resultat.

The hole in the polymer crib should be drilled in the same size as the rod. A worn drill head gives the best result.



Double water supply

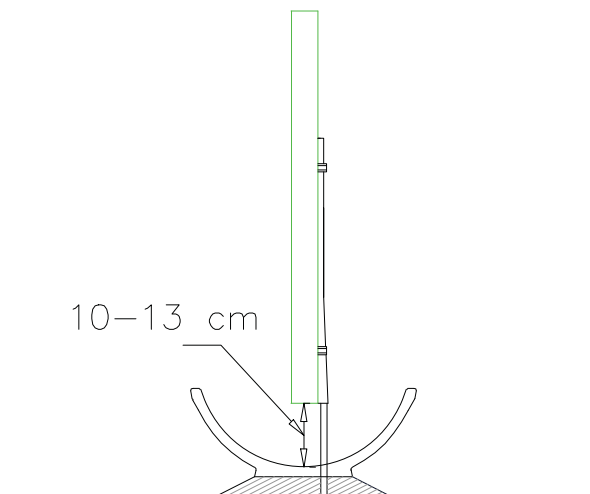
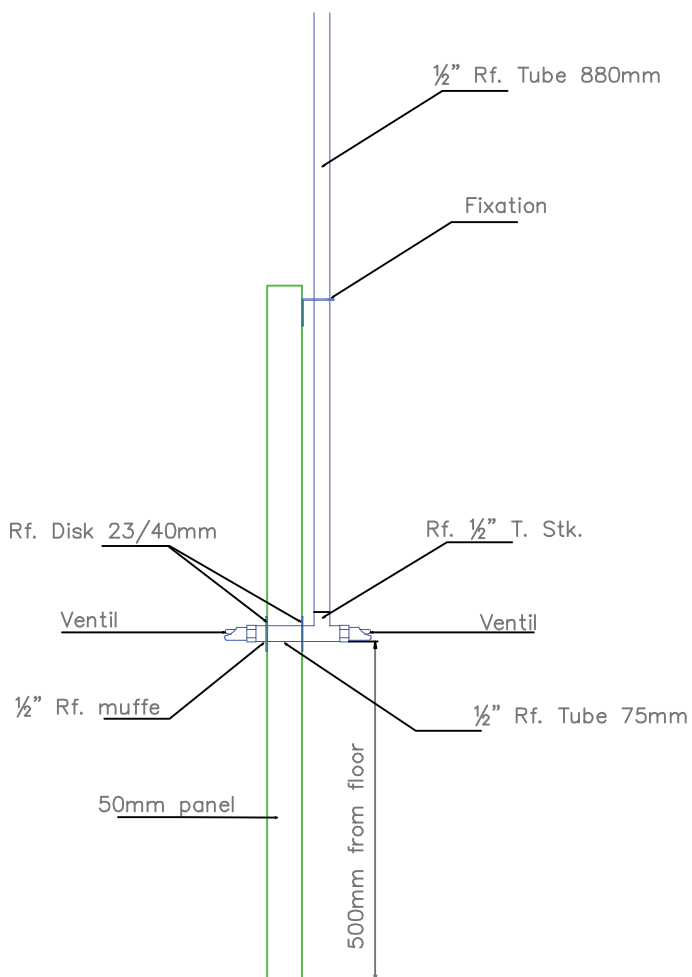

Door model
Easy M

30 - 130 Kg.

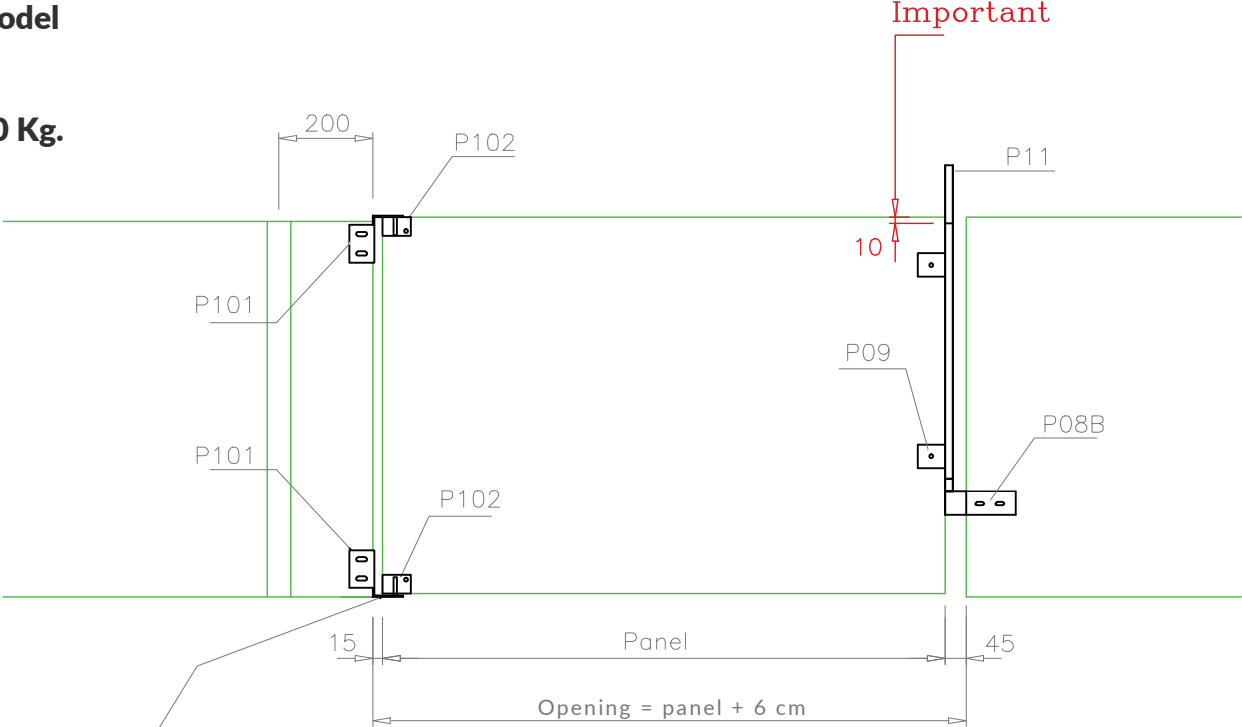

Adjustable with disk Ø12 x 37 mm

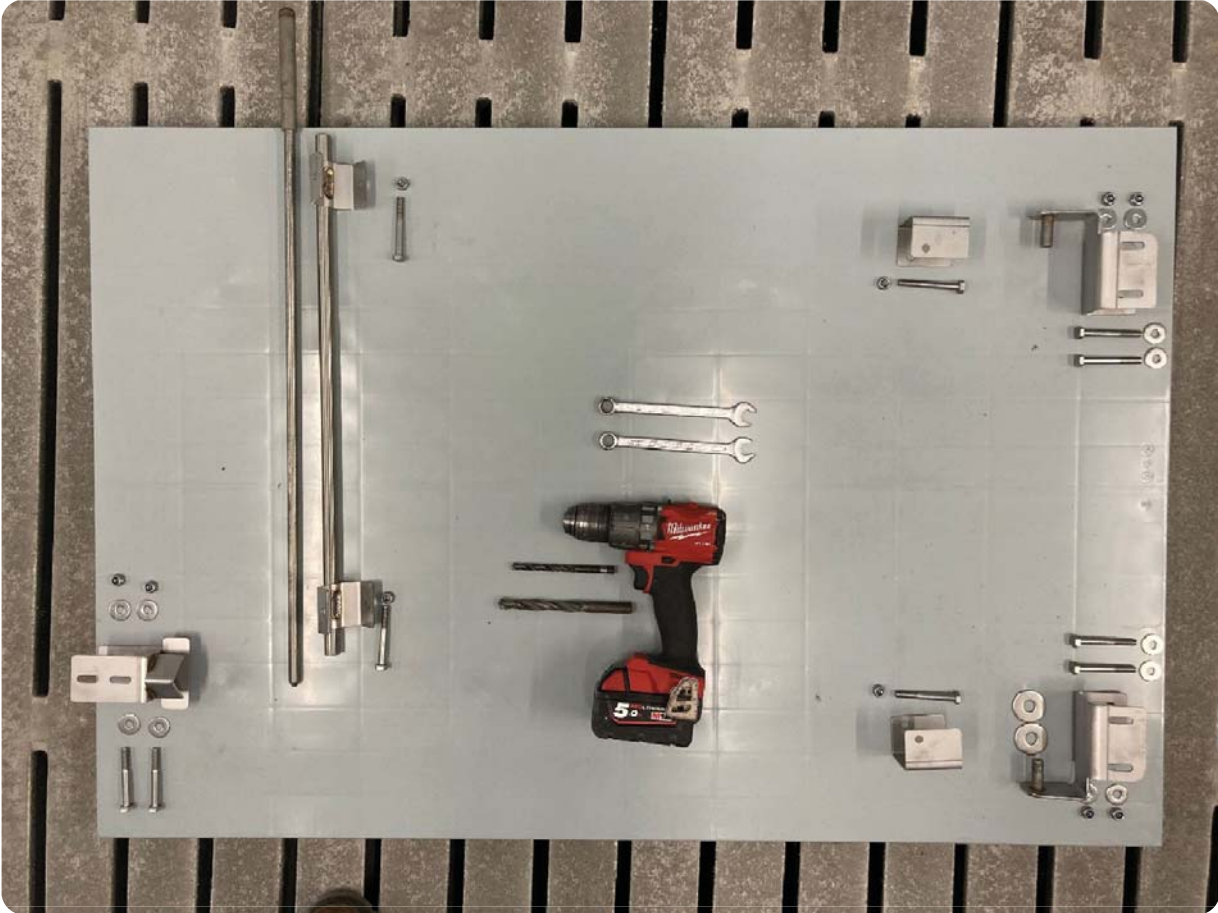

1 drill 8,5mm, 1 drill 12,5mm, Panel for door plate + 6-7cm = door opening

Door model Easy L

Søer/Sows

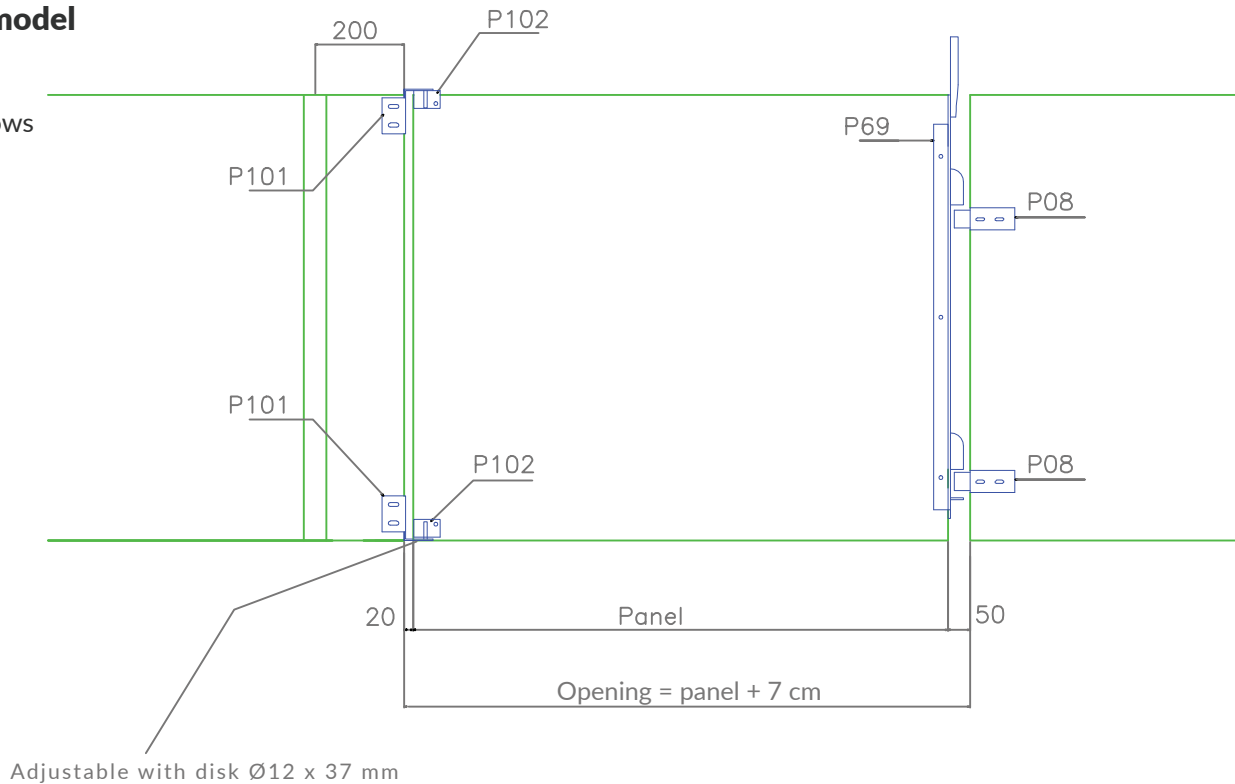

Spærrelåge model Easy-Flex/ barrier door Easy-Flex

Virker på ujævnt/skrående gulv
Belaster ikke hængselsiden unødigt

Works on uneven/rough floors
Does not load the hinge side unnecessary

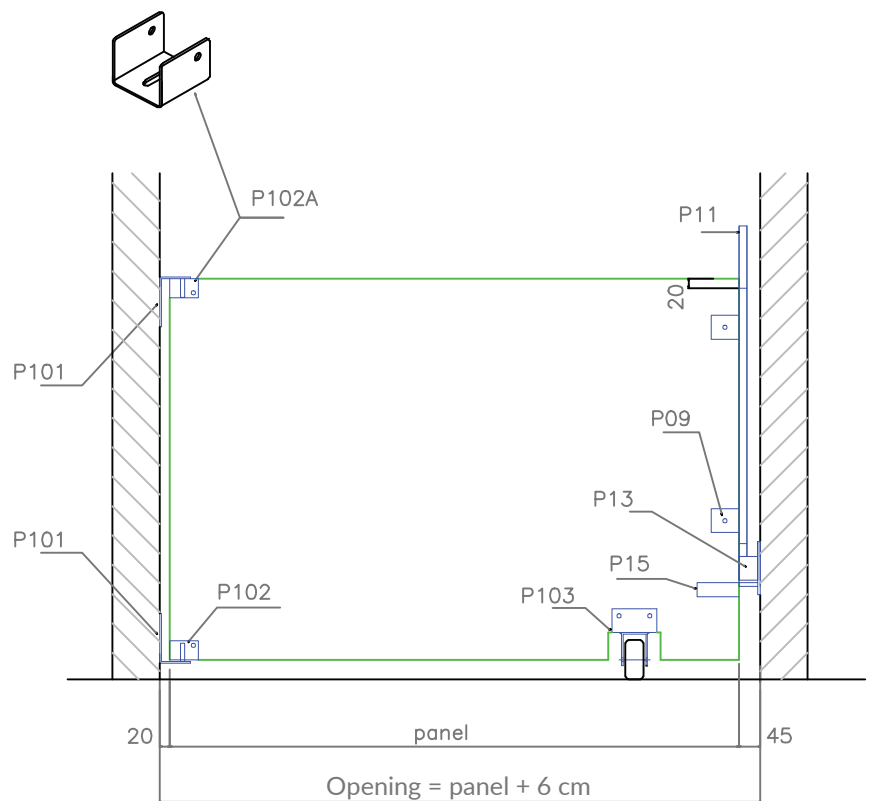

**Door model
Standard**

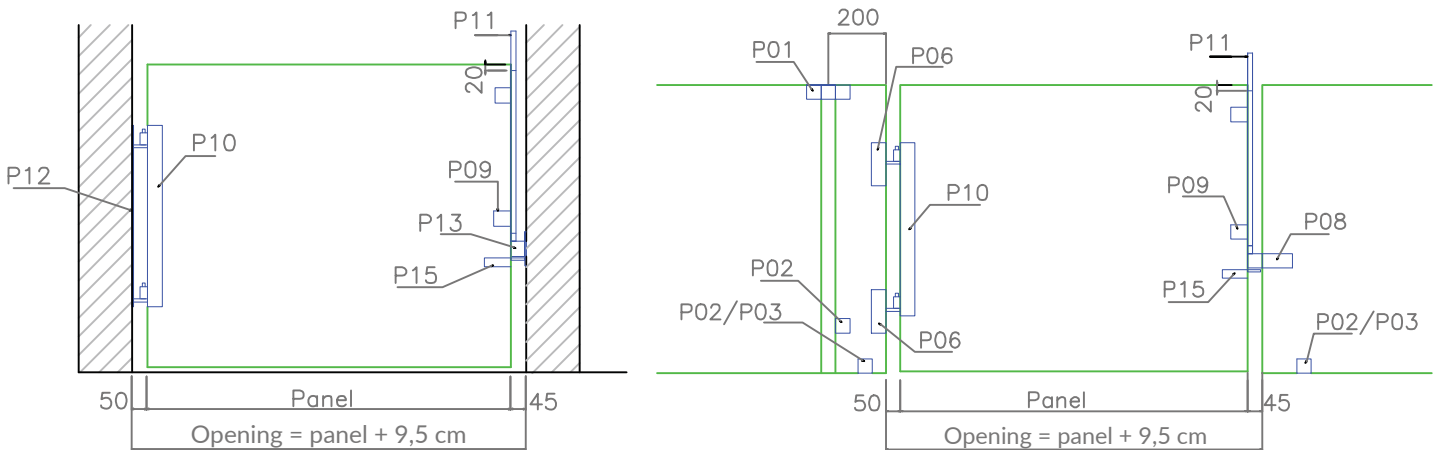

35mm System

**Door model
Easy S**

0-35 kg.

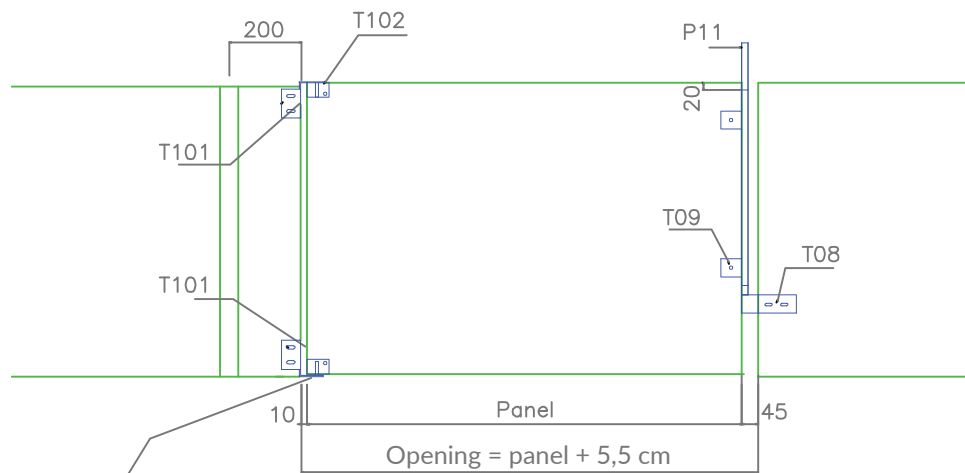

Adjustable with disk $\varnothing 12 \times 37 \text{ mm}$

2-Climate cover

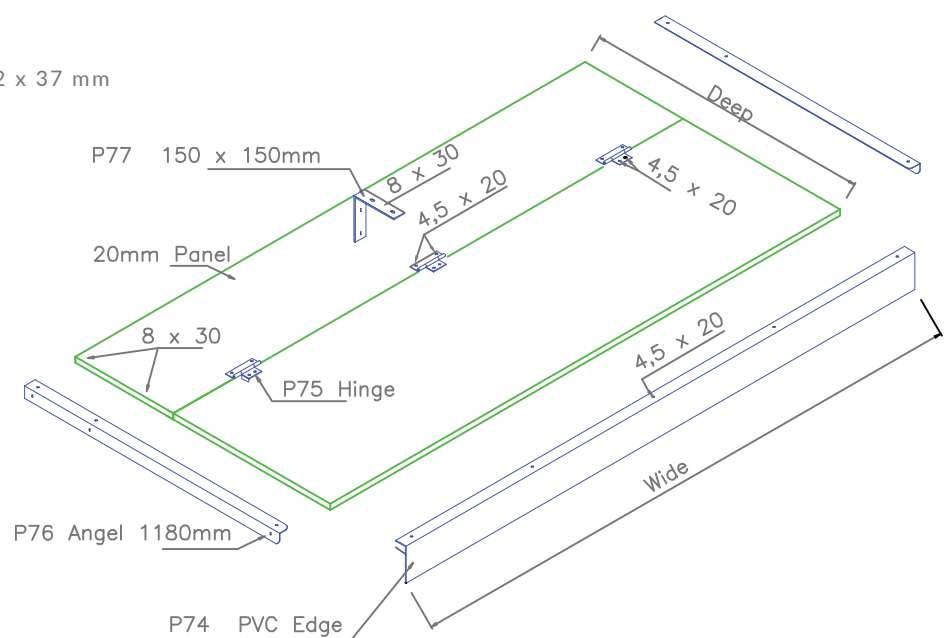

Knud Kjær Knudsen, Pigproducer full line Denmark.

"Panels with the built-in feeding pipe, makes the washing robot able to clean the wall almost 100%. And it's clever not to have any U-bolts and mounting parts around the feeding pipe, because we don't have anything that can go loose or broken over time.

The material is easy to drill into, making the installation straightforward. Plus, the panels do not need so many fitting parts, and since everything is stainless steel, we don't have to deal with rust or worn-out parts near the pigs. Even after 15-20 years, the panels maintain their strength, which means minimal maintenance for us. Overall, it's a simple and reliable solution!"

I would say that about 90% dirt on the walls is washed of by the robot and the rest is very easy to wash."

Thomas Ravn-Nielsen, Pigproducer finishers Denmark.

"I have bought stables where Paneltim Agro panels were installed in 1998, and we see no reasons to replace it. Over the last 20 years finisher pigs have become bigger before slaughtering, which sets more demands to the old inventory. From my experience the panels have required the lowest amount of maintenance and the door locking systems work perfectly also after many years.

The Panels are easy to work with during installation and fitting parts is very easy to mount. The installation process is very efficient.

There are not so many fitting parts because the panel is very self-supporting, leaving a smooth surface that is easy to clean.

Overall, this is a very strong product and price competitive because the installation is fast, all panels and parts fit when they arrive. And the panels + stainless-steel fittings do not wear out in the tough environment."

PANELTIM AGRO

Scandinavia ApS 



Paneltim Agro Scandinavia offers complete solutions worldwide

Request a free, no-obligation offer today!
Simply send us your drawings or give us a call,
and you will receive an attractive non-binding
offer within 48 hours

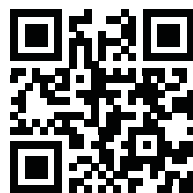

Scan me

Contact information



Paneltim Agro Scandinavia ApS
Kagstrupvej 2
DK-4160 Herlufmagle



0045-5545-0550



info@paneltimagro.dk